

Трансммиттеры температуры DELTA OHM HD978TR3, HD978TR4, HD978TR5, HD978TR6

Технические характеристики

Архангельск (8182)63-90-72
Астана (7172)727-132
Астрахань (8512)99-46-04
Барнаул (3852)73-04-60
Белгород (4722)40-23-64
Брянск (4832)59-03-52
Владивосток (423)249-28-31
Волгоград (844)278-03-48
Вологда (8172)26-41-59
Воронеж (473)204-51-73
Екатеринбург (343)384-55-89
Иваново (4932)77-34-06

Ижевск (3412)26-03-58
Иркутск (395)279-98-46
Казань (843)206-01-48
Калининград (4012)72-03-81
Калуга (4842)92-23-67
Кемерово (3842)65-04-62
Киров (8332)68-02-04
Краснодар (861)203-40-90
Красноярск (391)204-63-61
Курск (4712)77-13-04
Липецк (4742)52-20-81
Киргизия (996)312-96-26-47

Магнитогорск (3519)55-03-13
Москва (495)268-04-70
Мурманск (8152)59-64-93
Набережные Челны (8552)20-53-41
Нижний Новгород (831)429-08-12
Новокузнецк (3843)20-46-81
Новосибирск (383)227-86-73
Омск (3812)21-46-40
Орел (4862)44-53-42
Оренбург (3532)37-68-04
Пенза (8412)22-31-16
Казахстан (772)734-952-31

Пермь (342)205-81-47
Ростов-на-Дону (863)308-18-15
Рязань (4912)46-61-64
Самара (846)206-03-16
Санкт-Петербург (812)309-46-40
Саратов (845)249-38-78
Севастополь (8692)22-31-93
Симферополь (3652)67-13-56
Смоленск (4812)29-41-54
Сочи (862)225-72-31
Ставрополь (8652)20-65-13
Таджикистан (992)427-82-92-69

Сургут (3462)77-98-35
Тверь (4822)63-31-35
Томск (3822)98-41-53
Тула (4872)74-02-29
Тюмень (3452)66-21-18
Ульяновск (8422)24-23-59
Уфа (347)229-48-12
Хабаровск (4212)92-98-04
Челябинск (351)202-03-61
Череповец (8202)49-02-64
Ярославль (4852)69-52-93

Единый адрес для всех регионов: dmh@nt-rt.ru || www.deltaohm.nt-rt.ru

HD978TR3, HD978TR4, HD978TR5, HD978TR6



HD978TR3, HD978TR4, HD978TR5, HD978TR6 SIGNAL CONVERTERS / AMPLIFIERS WITH 4÷20mA OR 0÷10Vdc OUTPUT CONFIGURABLE WITH HD788-TCAL BY PC THROUGH RS232C

HD978TR3, HD978TR4, HD978TR5 and HD978TR6 are configurable signal converters/amplifiers configurable with mV input. The mV input signal range can be configured from -10mV to +60mV through a button, by using the HD778-TCAL simulator and DeltaLog7 software downloadable from Delta OHM website or a voltage calibrator with mV output. HD978TR3 and HD978TR5 have 4...20mA current output. HD978TR4 and HD978TR6 have 0...10Vdc voltage output.

0...1Vdc, 0...5Vdc and 1...5Vdc outputs are available on request. A led indicates the alarm situation and it helps user during the programming. The instrument is also protected against polarity inversions. Input and output are galvanically isolated: this is necessary to eliminate problems due to the mutual influence of the devices caused by the different ground paths.

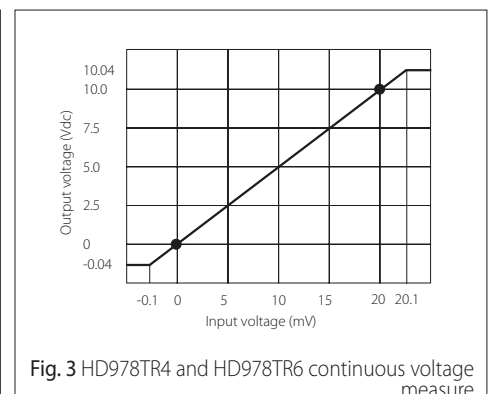
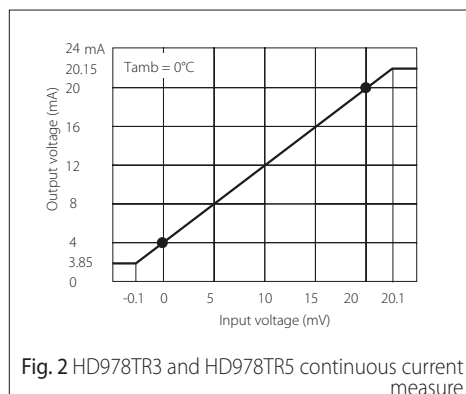
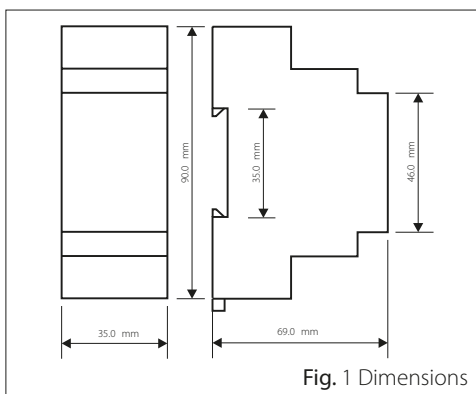

The instrument is housed in a 2 modules DIN (Width 35mm) container with standard connection for 35mm rail for the models HD978TR3 and HD978TR4; a wall mount container for the models HD978TR5 and HD978TR6. The 4...20mA current output of HD978TR3 and HD978TR5 is passive two-wire.

Technical Specifications @25°C and 24Vdc		
INPUT	HD978TR3 - HD978TR5	HD978TR4 - HD978TR6
Measuring range	-10mV ... +60mV configurable	
Default range	0...20mV	
Minimum measuring range	2mV	
Input impedance	> 1 Mohm	
Conversion speed	2 measures per second	
Accuracy	±0.04%F.S. ±20µV	
Operating temperature	-30 ... +70°C	
Storage temperature	-40...+80°C	
Relative humidity	0...90%RH (without condensation)	
OUTPUT	HD978TR3 - HD978TR5	HD978TR4 - HD978TR6
Type of output (note 1)	4...20 mA (or 20...4 mA) two-wired 22 mA, in case of unconnected input	0 ... 10Vdc (0...1Vcc, 0...5Vdc, 1...5Vdc upon request)
Resolution	4 µA	20 µV
Power supply	9...30Vdc for the 4...20mA current output	15...30Vdc (4mA) for the 0 ... 10Vcc current output, 10...30Vdc (4mA) for the other outputs
Protection against polarity inversion	40Vmax	
Sensitivity to Vdc power voltage variations	0.4 µA/V	2µA/V
Load resistance	$R_{LMax} = (V_{cc}-9)/0.022$ $R_{LMax} = 680\Omega$ with Vdc = 24 Vdc	> 10kΩ
Input/output galvanically isolation	50Vcc (verified at 250V)	
Red led	It turns on while programming, when the probe is broken or not connected	
Heating time	2 minutes	
Thermal drift	0.02% F.S./°C	

Note 1 - If the measured voltage V goes out of the V1...V2 (V1<V2) set range, the transmitters linearly regulate the output for V<V1 and V>V2 for an interval of 0.1mV. (See the diagrams of the outputs).

Installation and connection

Fig.1 shows the mechanical dimensions of the HD978TR3 and TR4: the width of the container is a 2 modules DIN (35mm). Fig.5 reports the wiring diagrams of the HD978TR3 and a Delta OHM pyranometer. Fig.6 indicates the typical connection of the HD978TR4.

In order to obtain the maximum precision, the connection to the thermocouple should not exceed 3 meters long and should be performed with a shielded cable. It is also recommended not to pass wiring near cable for power signals (electric motors, induction furnaces, inverter etc.). The working temperature should be within the declared operating temperature.

In the diagrams reported, the RL (Load) symbol represents any device introduced in the current loop, that is to say any indicator, controller, data logger or recorder. The two terminals reporting ground are connected internally between them and they are necessary to connect the ground terminal coming, for instance, by a pyranometer to the grounded, as you can see from the diagrams.

The response curves of the instruments are reported in figures 2 (current output of HD978TR3 and HD978TR5) and 3 (voltage output of HD978TR4 and HD978TR6).

Fig.7 reports, as an example, the connection to be performed for reading the voltage measured on a shunt DC: the converter assures the galvanic isolation between device and voltage or current output; also configurability allows to obtain the best correlation between read and amplified output voltage. We recommend that you pick up the signal by using a shielded cable and by connecting the shield to terminal 9.

Programming of the operating range

Converters HD978TR3, HD978TR4, HD978TR5 and HD978TR6 are supplied by default with range 0...20mV. The user can set a different range according to his requirements with a minimum span of 2mV. The correspondence between the read voltage and current or voltage output can be directed (for ex. 0mV / 4mA and 20mV / 20mA) or reverse (for ex. 20mV / 4mA and 0mV / 20mA).

Acquire the following tools for programming:

- DC Power source (please see the specifications table),
- calibrator with mV output,
- connection cables,
- precision ammeter with 0...25 mA minimum range or 0...10Vdc voltmeter.

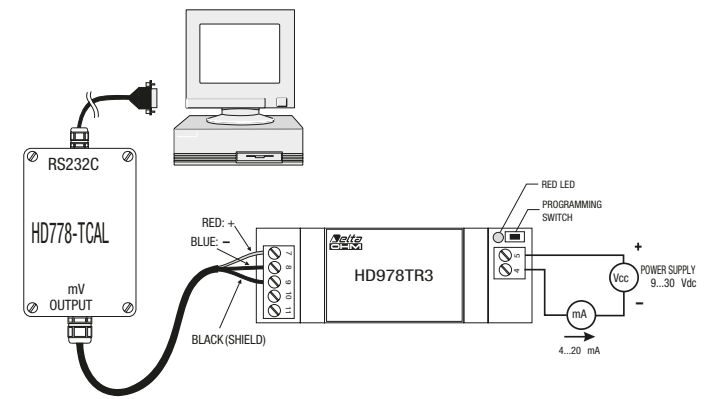

The setting must be done with the instrument already powered.

Set the calibrator so that it generates the voltage corresponding to the output of the initial scale of the converter (4mA or 0V according to the model), by paying attention to polarity. Wait 30 seconds for the voltage to stabilize. Press and hold the button until the led starts flashing. Release the button. The instrument has acquired the first value of the transmitter working range, the led keeps on flashing. The instrument is now awaiting the value of the full scale range.

Set the calibrator in order to generate a voltage corresponding to the output of the full scale (20mA or 10Vdc).

Press and hold the button until the led stops flashing. Release the button and wait 20 seconds, without changing the calibrator's data, so that the converter saves the calibration data and is ready for working normally. The operation ends with a flashing of the led. The instrument has acquired the second point corresponding to the range you want to set and is working normally. The minimum value accepted by the instrument is 2mV. If after having inserted the first range value V1 the user tries to insert a second value V2 with: V2-V1 lower than 2mV, the instrument does not accept it and remains in standby while the led flashing continuously.

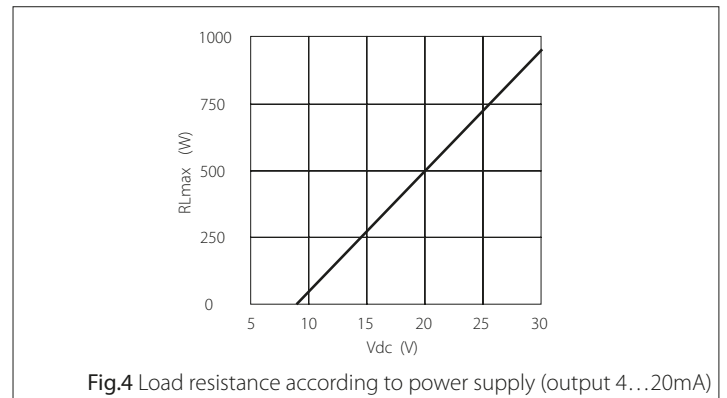

Fig.4 Load resistance according to power supply (output 4...20mA)

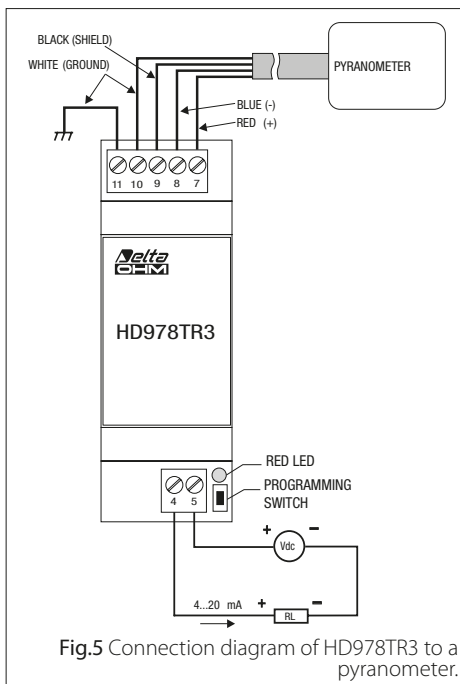

Fig.5 Connection diagram of HD978TR3 to a pyranometer.

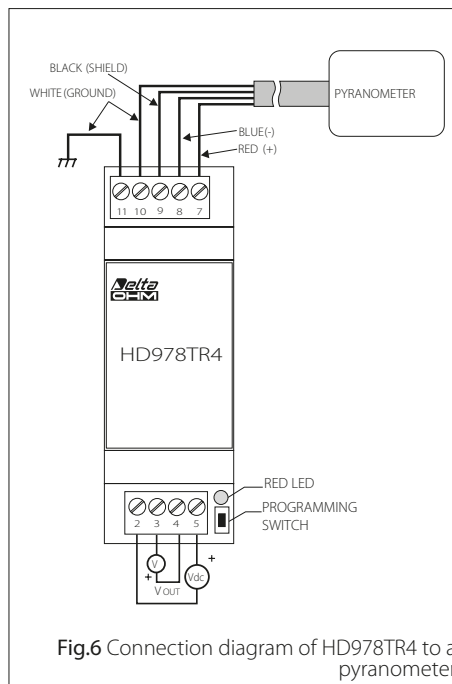

Fig.6 Connection diagram of HD978TR4 to a pyranometer

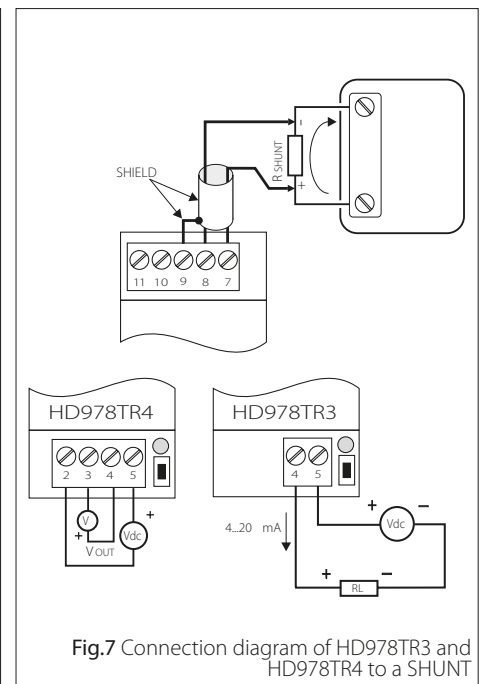

Fig.7 Connection diagram of HD978TR3 and HD978TR4 to a SHUNT

Note: in place of the current/voltage calibrator, you can use the Delta OHM HD778-TCAL. This instrument has to be connected to a serial port of the PC and, by means of the DeltaLog7 software downloadable from Delta OHM website, automates all the steps described above for programming the operating range.

The HD778-TCAL is supplied with its software. Connected to the HD778-TCAL serial output of a PC, the user can configure the HD978TR3 and HD978TR5 (4...20mA or 20...4mA current) or the HD978TR4 and HD978TR6 (0...10Vdc or 10...0Vdc voltage) by following the instructions on the screen.

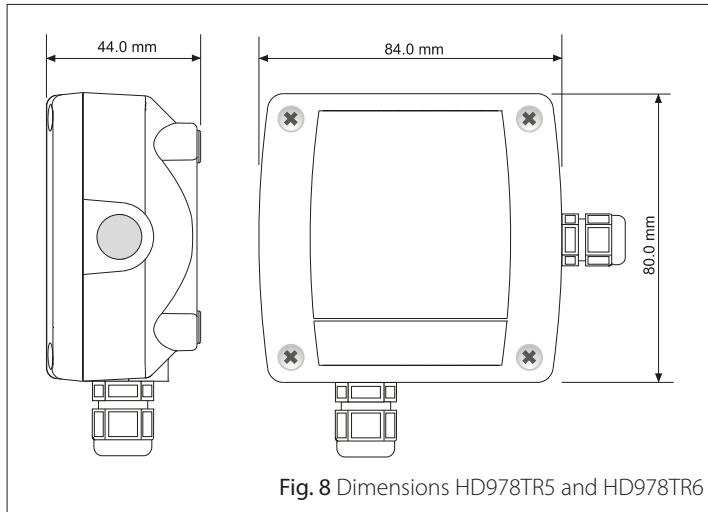

Fig. 8 Dimensions HD978TR5 and HD978TR6

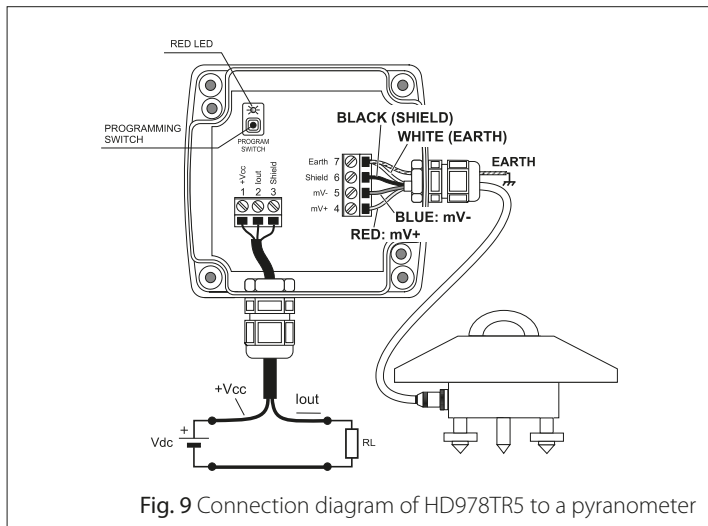

Fig. 9 Connection diagram of HD978TR5 to a pyranometer

ORDERING CODES

HD978TR3: Configurable signal converter amplifier with **4÷20mA (20÷4mA) output, for DIN rail.** Input measuring range -10...+60mV. Default setting 0÷20mV. Minimum measuring range 2mV.

HD978TR4: Configurable signal converter amplifier with **0÷10Vdc (10÷0Vdc) output, for DIN rail.** Input measuring range -10...+60mV. Default setting 0÷20mV. Minimum measuring range 2mV.

HD978TR5: Wall mounting configurable signal converter amplifier with **4÷20mA (20÷4mA) output.** Input measuring range -10...+60mV. Default setting 0÷20mV. Minimum measuring range 2mV.

HD978TR6: Wall mounting configurable signal converter amplifier with **0÷10Vdc (10÷0Vdc) output.** Input measuring range -10...+60mV. Default setting 0÷20mV. Minimum measuring range 2mV.

HD778-TCAL: power generator in the range -60mV...+60mV, regulated by PC through RS232C serial port, DeltaLog7 software downloadable from Delta OHM website for setting K, J, T and N thermocouple transmitters.

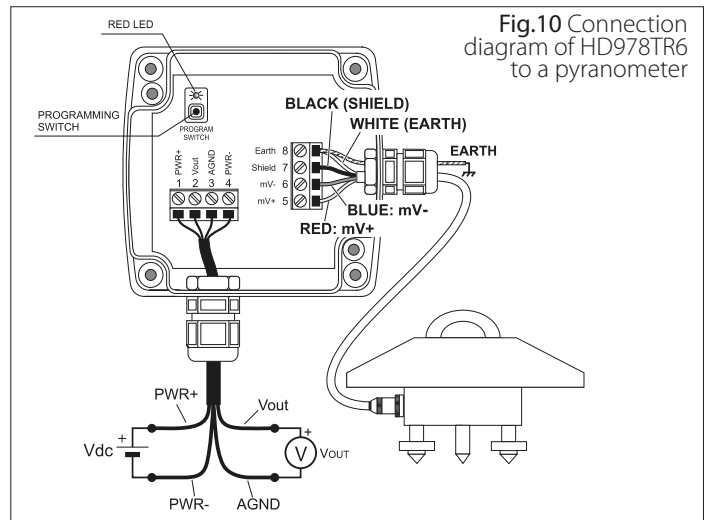

Fig. 10 Connection diagram of HD978TR6 to a pyranometer

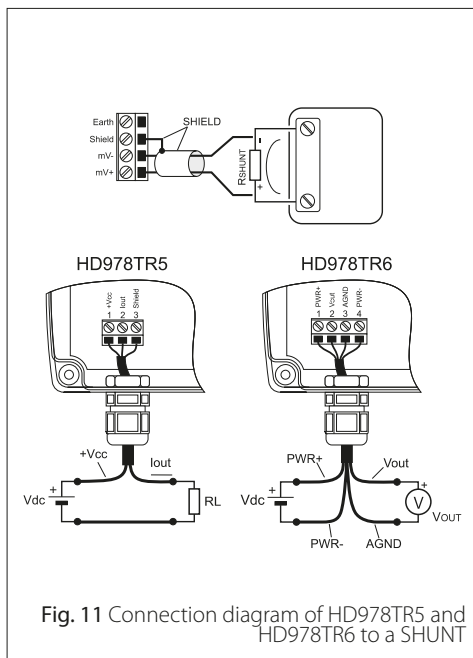

Fig. 11 Connection diagram of HD978TR5 and HD978TR6 to a SHUNT

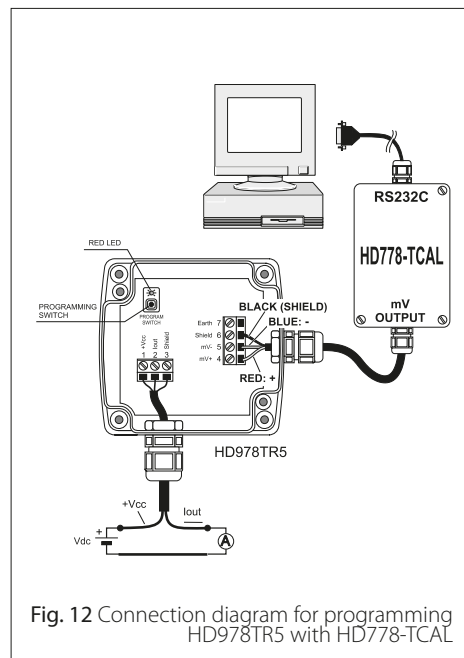

Fig. 12 Connection diagram for programming HD978TR5 with HD778-TCAL

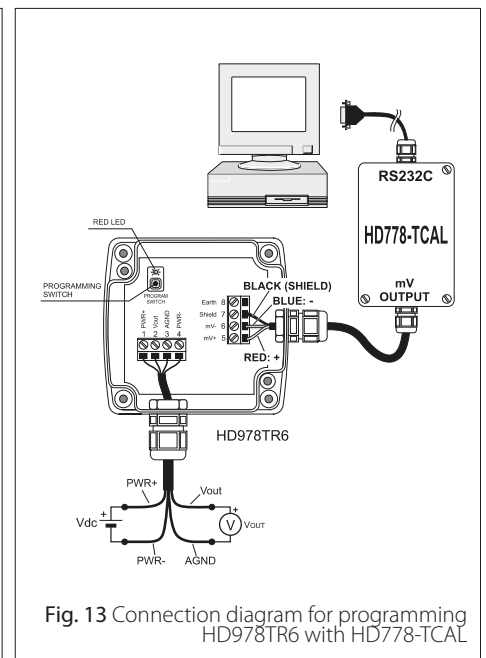

Fig. 13 Connection diagram for programming HD978TR6 with HD778-TCAL

Архангельск (8182)63-90-72	Ижевск (3412)26-03-58	Магнитогорск (3519)55-03-13	Пермь (342)205-81-47	Сургут (3462)77-98-35
Астана (7172)727-132	Иркутск (395)279-98-46	Москва (495)268-04-70	Ростов-на-Дону (863)308-18-15	Тверь (4822)63-31-35
Астрахань (8512)99-46-04	Казань (843)206-01-48	Мурманск (8152)59-64-93	Рязань (4912)46-61-64	Томск (3822)98-41-53
Барнаул (3852)73-04-60	Калининград (4012)72-03-81	Набережные Челны (8552)20-53-41	Самара (846)206-03-16	Тула (4872)74-02-29
Белгород (4722)40-23-64	Калуга (4842)92-23-67	Нижний Новгород (831)429-08-12	Санкт-Петербург (812)309-46-40	Тюмень (3452)66-21-18
Брянск (4832)59-03-52	Кемерово (3842)65-04-62	Новокузнецк (3843)20-46-81	Саратов (845)249-38-78	Ульяновск (8422)24-23-59
Владивосток (423)249-28-31	Киров (8332)68-02-04	Новосибирск (383)227-86-73	Севастополь (8692)22-31-93	Уфа (347)229-48-12
Волгоград (844)278-03-48	Краснодар (861)203-40-90	Омск (3812)21-46-40	Симферополь (3652)67-13-56	Хабаровск (4212)92-98-04
Вологда (8172)26-41-59	Красноярск (391)204-63-61	Орел (4862)44-53-42	Смоленск (4812)29-41-54	Челябинск (351)202-03-61
Воронеж (473)204-51-73	Курск (4712)77-13-04	Оренбург (3532)37-68-04	Сочи (862)225-72-31	Череповец (8202)49-02-64
Екатеринбург (343)384-55-89	Липецк (4742)52-20-81	Пенза (8412)22-31-16	Ставрополь (8652)20-65-13	Ярославль (4852)69-52-93
Иваново (4932)77-34-06	Киргизия (996)312-96-26-47	Казахстан (772)734-952-31	Таджикистан (992)427-82-92-69	

Единый адрес для всех регионов: dmh@nt-rt.ru || www.deltaohm.nt-rt.ru