

Гигрометры DELTA OHM HD3817T, HD38V17T

Технические характеристики

Архангельск (8182)63-90-72	Ижевск (3412)26-03-58	Магнитогорск (3519)55-03-13	Пермь (342)205-81-47	Сургут (3462)77-98-35
Астана (7172)727-132	Иркутск (395)279-98-46	Москва (495)268-04-70	Ростов-на-Дону (863)308-18-15	Тверь (4822)63-31-35
Астрахань (8512)99-46-04	Казань (843)206-01-48	Мурманск (8152)59-64-93	Рязань (4912)46-61-64	Томск (3822)98-41-53
Барнаул (3852)73-04-60	Калининград (4012)72-03-81	Набережные Челны (8552)20-53-41	Самара (846)206-03-16	Тула (4872)74-02-29
Белгород (4722)40-23-64	Калуга (4842)92-23-67	Нижний Новгород (831)429-08-12	Санкт-Петербург (812)309-46-40	Тюмень (3452)66-21-18
Брянск (4832)59-03-52	Кемерово (3842)65-04-62	Новокузнецк (3843)20-46-81	Саратов (845)249-38-78	Ульяновск (8422)24-23-59
Владивосток (423)249-28-31	Киров (8332)68-02-04	Новосибирск (383)227-86-73	Севастополь (8692)22-31-93	Уфа (347)229-48-12
Волгоград (844)278-03-48	Краснодар (861)203-40-90	Омск (3812)21-46-40	Симферополь (3652)67-13-56	Хабаровск (4212)92-98-04
Вологда (8172)26-41-59	Красноярск (391)204-63-61	Орел (4862)44-53-42	Смоленск (4812)29-41-54	Челябинск (351)202-03-61
Воронеж (473)204-51-73	Курск (4712)77-13-04	Оренбург (3532)37-68-04	Сочи (862)225-72-31	Череповец (8202)49-02-64
Екатеринбург (343)384-55-89	Липецк (4742)52-20-81	Пенза (8412)22-31-16	Ставрополь (8652)20-65-13	Ярославль (4852)69-52-93
Иваново (4932)77-34-06	Лиргизия (996)312-96-26-47	Казахстан (772)734-952-31	Таджикистан (992)427-82-92-69	

Единый адрес для всех регионов: dmh@nt-rt.ru || www.deltaohm.nt-rt.ru

HD3817T... HD38V17T...



HD3817T..., HD38V17T... ABSOLUTE HUMIDITY AND TEMPERATURE ACTIVE TRANSMITTER

The HD3817T... and HD38V17T... are double **absolute humidity and temperature active transmitters** with 4...20 mA current or 0...10 Vdc voltage outputs, respectively.

Absolute humidity is the ratio between the mass of water vapour and the measured volume of air, and is expressed in g/m^3 . The transmitters of the HD3817T... family may be used in materials humidity control during a drying process. When the materials are dried through heating or a hot air flow, the air absolute humidity increase is directly proportional to the quantity of water lost by the materials. A control system measuring absolute humidity, can maintain a certain humidity level by injecting vapour or water spray in the environment, if needed. Generally, these transmitters are employed in the chemical, textile, food industry, in the production and storage of paper, in the drying of wood,... even with high temperatures and wide humidity excursions. The type of sensor used is immune to most physical and chemical contaminants. The maximum working temperature is 200 °C: this makes these instruments particularly suitable to heavy industrial applications where the traditional capacitive sensor cannot be used.

The response time is fast, as well as the recovery time from saturation.

The maximum measurement ranges are: 0...130 g/m^3 for absolute humidity and 0...200 °C for temperature: The instruments come out of the factory with the 0...60 g/m^3 and 0...200 °C standard ranges. You can request, when placing the order, different ranges both for absolute humidity and temperature, but within the set limits.

The standard power supply is 24VAC. On request, 115VAC or 230VAC versions are available.

The probe is made of stainless steel and has a 20 μm sintered bronze filter. The case is in polycarbonate with an IP66 protection degree.

The instruments have IP66 protection degree.

Technical specifications

Absolute Humidity	Type of sensor	Heat conductivity with double combined NTC.
	Sensor protection	20 μm sintered bronze filter
	Measurement range	0...130 g/m^3 (0...100% RH @60 °C and 1013hPa) (*)
	Sensor working range	0 ... +200 °C
	Accuracy	$\pm 3\text{g}/\text{m}^3$ at 35 g/m^3 and 40 °C
	Startup stabilization time	120 seconds
	Response time	60 seconds with standard filter for a 63% variation of the final value
Temperature	Repeatability	$\pm 5\%$
	Sensors type	4 wire Pt100
	Measurement range	0 ... +200 °C
	Accuracy	$\frac{1}{3}$ DIN
Analog outputs (according to the models)	4...20 mA (HD3817T...)	$R_L < 500\Omega$
	0...10 Vdc (HD38V17T...)	$R_L > 10k\Omega$
General Characteristics	Power supply voltage	24Vac $\pm 10\%$ 50...60Hz On request, 115Vac or 230Vac $\pm 10\%$ 50...60Hz
	Consumption	4VA typical
	Temperature / Electronic Working Humidity	-10 °C ... +70 °C / 5...90% RH without condensation
	Case size	120x80x55 mm
	Protection Degree	IP66 probe excluded
	Case material	Polycarbonate
	Probe material	Stainless steel AISI304

(*)Note: The 0...130 g/m^3 range is referred to a 60 °C temperature. The absolute humidity maximum value varies with environment temperature according to the following diagram.

DIAGRAM OF THE ABSOLUTE HUMIDITY AND TEMPERATURE OUTPUTS

The graphs of the absolute humidity and temperature outputs are reported below.

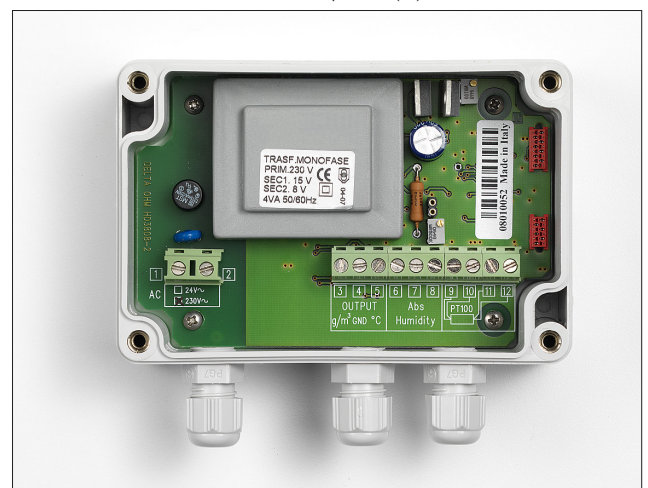
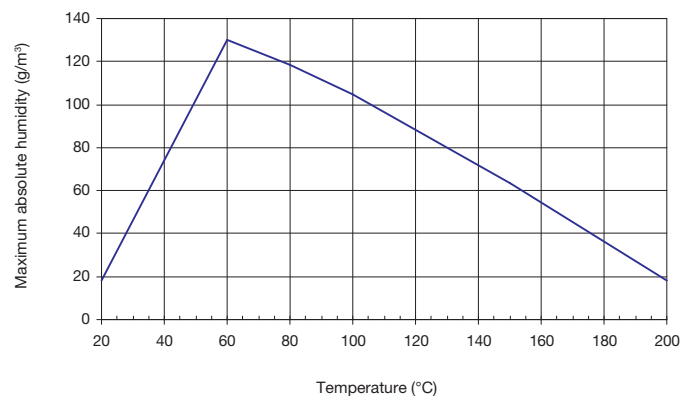

Absolute humidity (g/m³)

4...20 mA current output according to 0...60g/m³ standard range

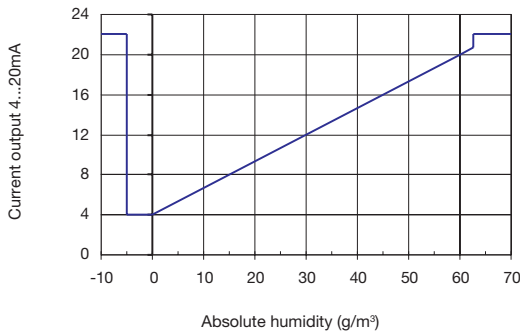

Temperature (°C)

4...20 mA current output according to 0...200 °C standard range

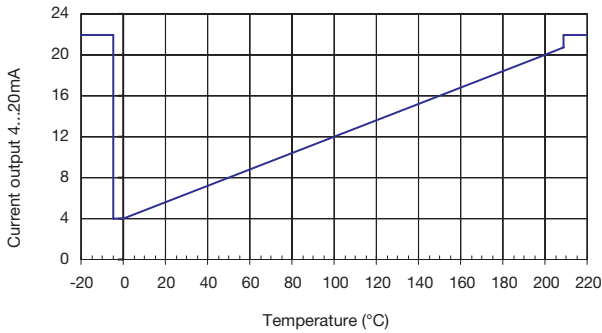

Absolute humidity (g/m³)

0...10 Vdc voltage output according to 0...60g/m³ standard range

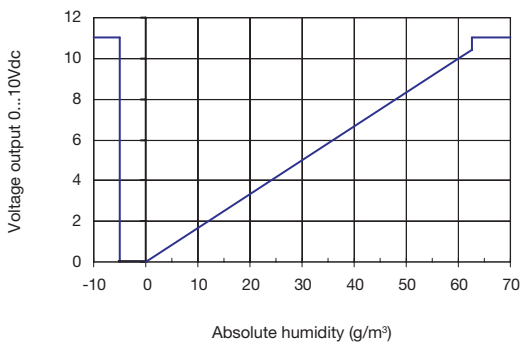

Temperature (°C)

0...10 Vdc voltage output according to 0...200 °C standard range

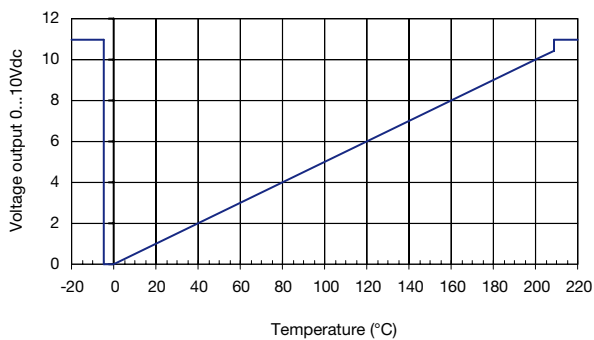

Calibration

The instruments are calibrated in the factory; no calibration is required by the user.

INSTALLATION NOTES

Each probe is calibrated in the factory with its transmitter: probe cannot be used onto another transmitter. The transmitter has to be installed into a position with good air circulation. The probe orientation is not important. To set the probe in a ventilation channel, into a duct, inside a dryer, etc. you can use the HD9008.31.12 flange, a PG16 (Ø10...14mm) metallic fairlead or a 3/8" biconical universal fitting.

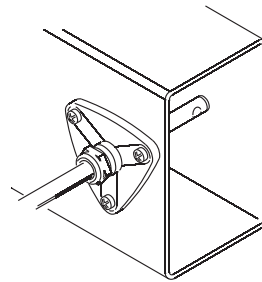

HD9008.31.12 flange

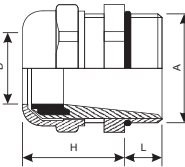

PG16.12 metallic fairlead
D = 14 mm
L = 6.5 mm
H = 23 mm
A = PG16

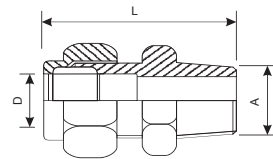

Biconical universal fitting
L = 35 mm
D = 14 mm
A = 3/8

ELECTRIC CONNECTION

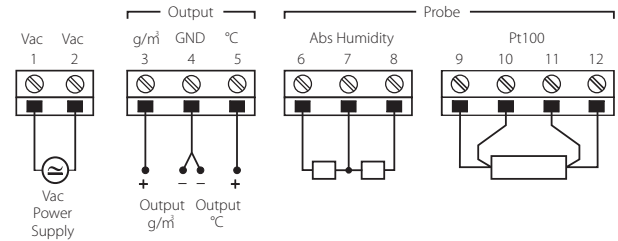

Power

Apply power to the instrument with the correct VAC voltage between the power supply terminals ① and ②.

Connection of the absolute humidity and temperature probe

Connect the probe respecting the colours and the numbers in the following table:

Function	Terminal Number	Cable Colour
Absolute Humidity	6	Red
	7	White
	8	Yellow
Pt100 Temperature	9	Blue
	10	Blue
	11	Black
	12	Black

Analog outputs

The output signals are acquired between the terminals:

③=g/m³ and ④=GND for absolute humidity,
⑤=°C and ⑥=GND for temperature.

DIMENSION

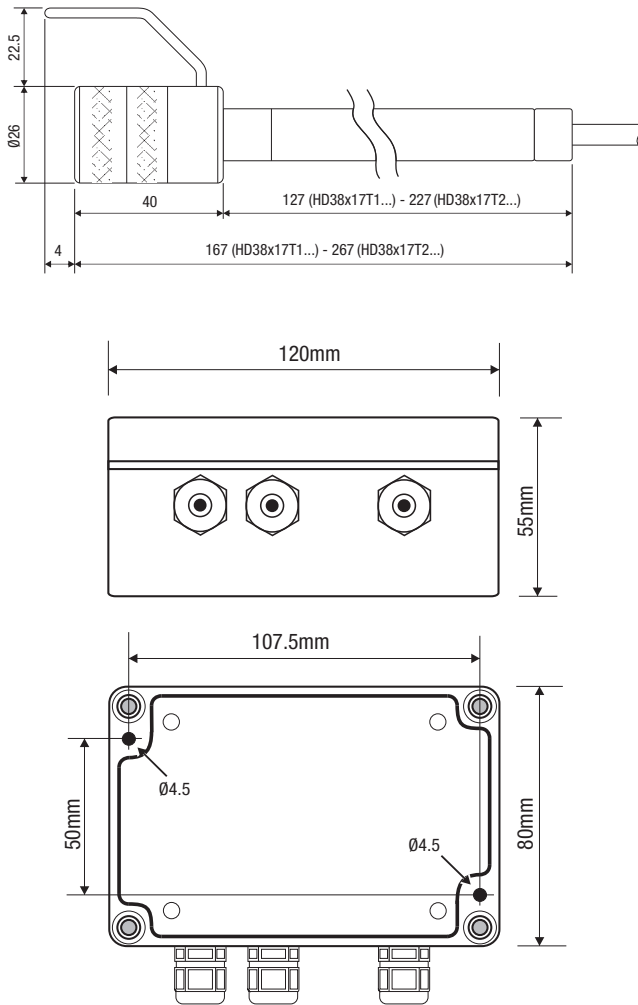

ORDERING CODES

HD3817T...: Absolute humidity and Pt100 temperature double transmitter. Analog output 4...20 mA. Measurement range of absolute humidity 0...60g/m³, temperature 0...+200 °C (On request, when making the order, other outputs in the range, 0...130g/m³ and 0...+200 °C). Probe with 20µm sintered bronze filter AISI304. Electronic working temperature -10...+70 °C. Probe working temperature 0...+200 °C.
When making the order, please specify 1) Power supply 2) Stem length 127mm or 227mm. 3) Probe's cable length 2m or 5m.

HD38V17T...: Absolute humidity and Pt100 temperature double transmitter. Analog output 0...10 Vdc. Measurement range of absolute humidity 0...60g/m³, temperature 0...+200 °C (On request, when making the order, other outputs in the range, 0...130g/m³ and 0...+200 °C). Probe with 20µm sintered bronze filter AISI304. Electronic working temperature -10...+70 °C. Probe working temperature 0...+200 °C.
When making the order, please specify 1) Power supply 2) Stem length 127mm or 227mm. 3) Probe's cable length 2m or 5m.

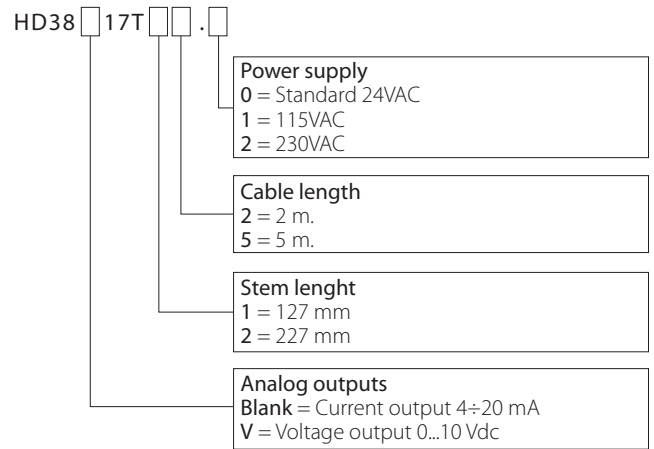

RELATION BETWEEN ABSOLUTE HUMIDITY, RELATIVE HUMIDITY E MIXING RATIO

$$\%RH = \frac{100 \cdot E}{E_s}$$

$$AH = \frac{804 \cdot E}{(1 + 0.00366 \cdot T) \cdot P_0}$$

$$MR = \frac{0.622 \cdot E}{P_0 - E}$$

%RH = % of relative humidity

AH = absolute humidity in g/m³

MR = Mixing ratio in water vapour kg per air kg

E = Current value of vapour pressure in air in Pascal

E_s = Saturated vapour pressure in air in Pascal

P₀ = Atmospheric pressure in Pascal

T = temperature in Celsius degrees

the E_s value can be obtain from a psychrometric table



Архангельск (8182)63-90-72	Ижевск (3412)26-03-58	Магнитогорск (3519)55-03-13	Пермь (342)205-81-47	Сургут (3462)77-98-35
Астана (7172)727-132	Иркутск (395)279-98-46	Москва (495)268-04-70	Ростов-на-Дону (863)308-18-15	Тверь (4822)63-31-35
Астрахань (8512)99-46-04	Казань (843)206-01-48	Мурманск (8152)59-64-93	Рязань (4912)46-61-64	Томск (3822)98-41-53
Барнаул (3852)73-04-60	Калининград (4012)72-03-81	Набережные Челны (8552)20-53-41	Самара (846)206-03-16	Тула (4872)74-02-29
Белгород (4722)40-23-64	Калуга (4842)92-23-67	Нижний Новгород (831)429-08-12	Санкт-Петербург (812)309-46-40	Тюмень (3452)66-21-18
Брянск (4832)59-03-52	Кемерово (3842)65-04-62	Новокузнецк (3843)20-46-81	Саратов (845)249-38-78	Ульяновск (8422)24-23-59
Владивосток (423)249-28-31	Киров (8332)68-02-04	Новосибирск (383)227-86-73	Севастополь (8692)22-31-93	Уфа (347)229-48-12
Волгоград (844)278-03-48	Краснодар (861)203-40-90	Омск (3812)21-46-40	Симферополь (3652)67-13-56	Хабаровск (4212)92-98-04
Вологда (8172)26-41-59	Красноярск (391)204-63-61	Орел (4862)44-53-42	Смоленск (4812)29-41-54	Челябинск (351)202-03-61
Воронеж (473)204-51-73	Курск (4712)77-13-04	Оренбург (3532)37-68-04	Сочи (862)225-72-31	Череповец (8202)49-02-64
Екатеринбург (343)384-55-89	Липецк (4742)52-20-81	Пенза (8412)22-31-16	Ставрополь (8652)20-65-13	Ярославль (4852)69-52-93
Иваново (4932)77-34-06	Лиргизия (996)312-96-26-47	Казахстан (772)734-952-31	Таджикистан (992)427-82-92-69	

Единый адрес для всех регионов: dmh@nt-rt.ru || www.deltaohm.nt-rt.ru